

Relays and Switches for the
Transportation
Market

Selection Guide

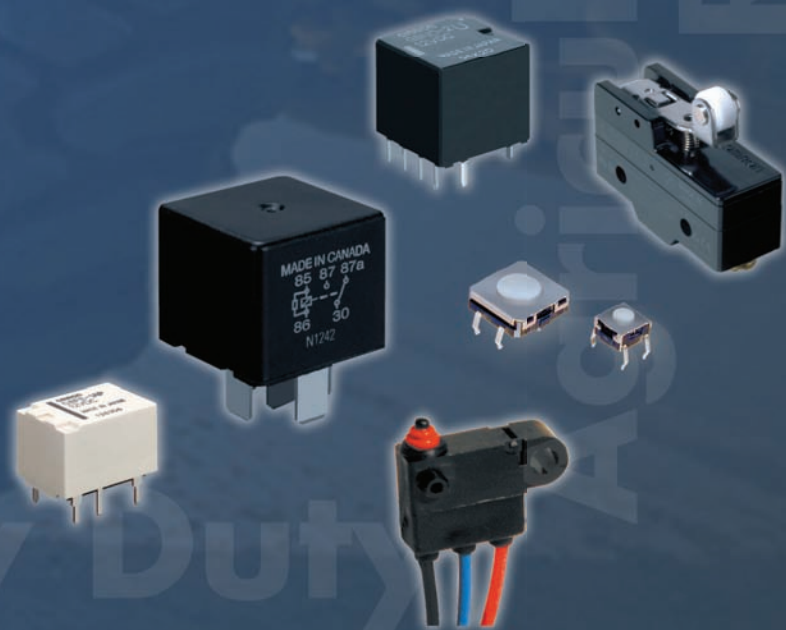

OMRON
ELECTRONIC COMPONENTS

OMRON Responds to IT Evolution with Four Advanced Technologies

Omron means reliable products and advanced technologies for the marketplace... Omron has developed electronic components such as relays, switches, & connectors as well as other innovative products meeting the needs of our age. Now, unique Omron technologies along with a worldwide supply network the promise of quality, performance, and delivery is being actualized. To satisfy the marketplace, Omron supports global business challenges by acting as a strategic partner supporting the activities of our customers.

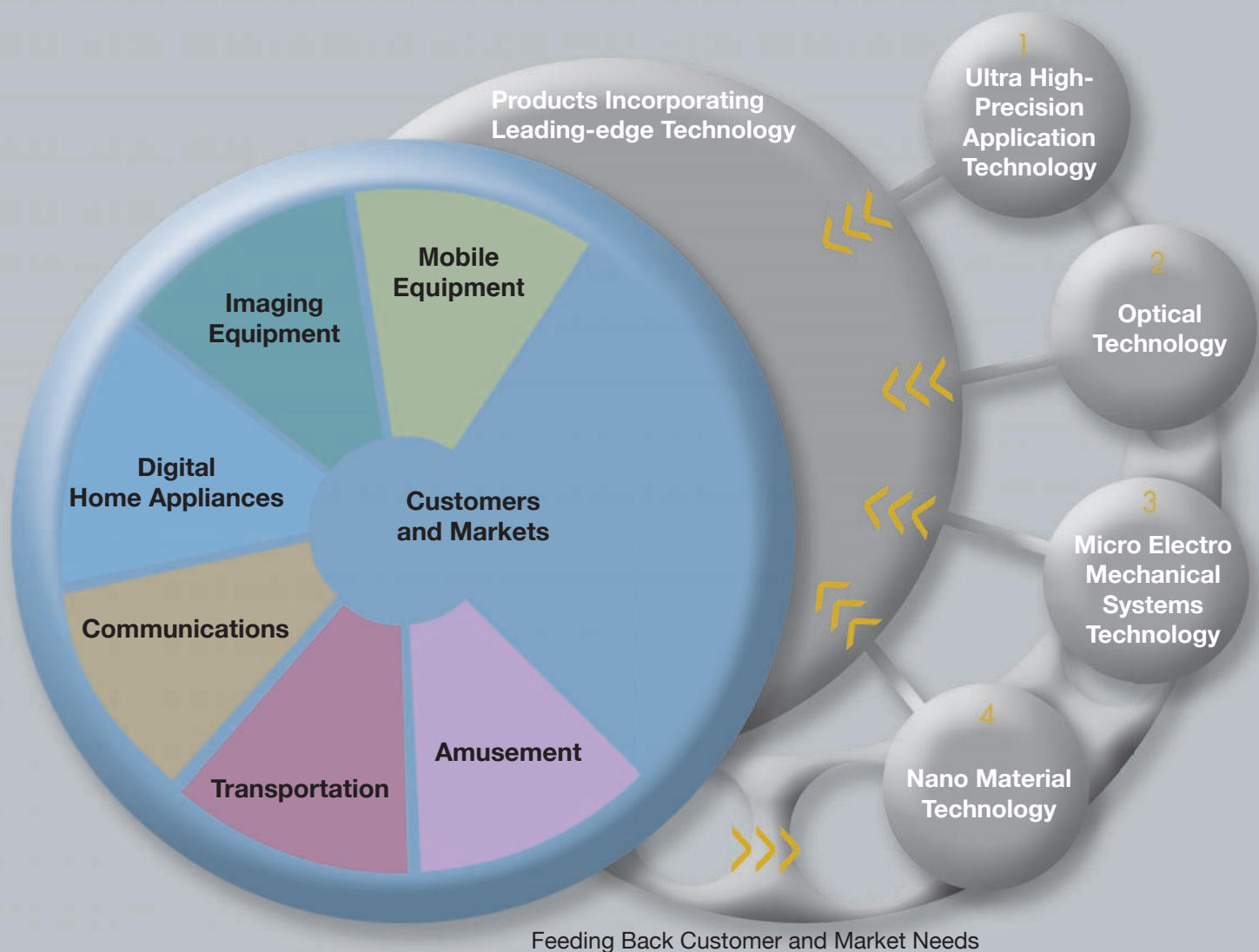

Four core technologies to meet customers' needs:

Investment in technology leads directly to mature expertise in the field. This expertise enables Omron to meet the dreams of the consumer marketplace.

Table of Contents

Relay Lineup	4
Relay Applications	6
Relay Series	8
Relays for Transportation Glossary	12
Switch Series	15



**Relays and Switches
for the Transportation Market**

Relay Line-up

Broad lineup to meet diversifying needs.
Focusing on small size, little heating and high wattage relays, new relays are added.

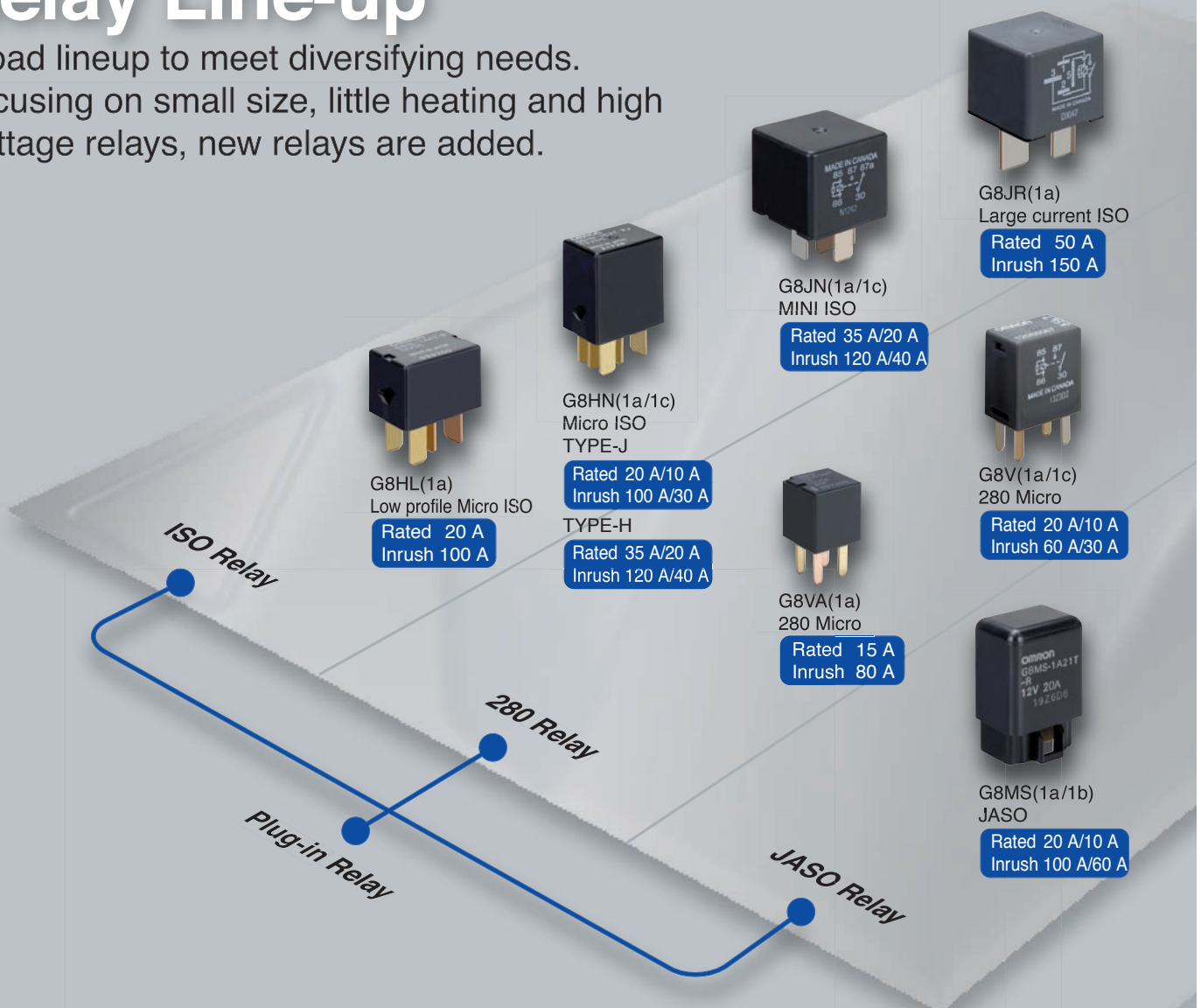

G8W(1a/1c)
280MINI

Rated 35 A/20 A
Inrush 120 A/40 A



G4R(1a)
JASO
Rated 25 A
Inrush 120 A



G4L(1a)
JASO
Rated 20 A
Inrush 100 A



G8PE(1a/1c)
Rated 40 A/25 A
Inrush 180 A/60 A



G8HL-P(1a)
Rated 20 A
Inrush 100 A



G8SE(1a)
Rated 20 A
Inrush 80 A

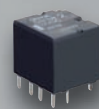

G8NW(1c x 2)
Rated 5 A
Max 30 A



G8SN(1c)
Rated 10 A
Max 35 A



G8FE(1a)
Rated 15 A
Inrush 80 A



G8QE(1a)
Rated 10 A
Inrush 60 A



G8ND(1c x 2)
(H-Bridge)
Rated 5 A
Max 30 A

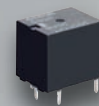

G8QN(1c)
Rated 5 A
Max 30 A



G8N(1c)
Rated 5 A
Max 30 A





Application



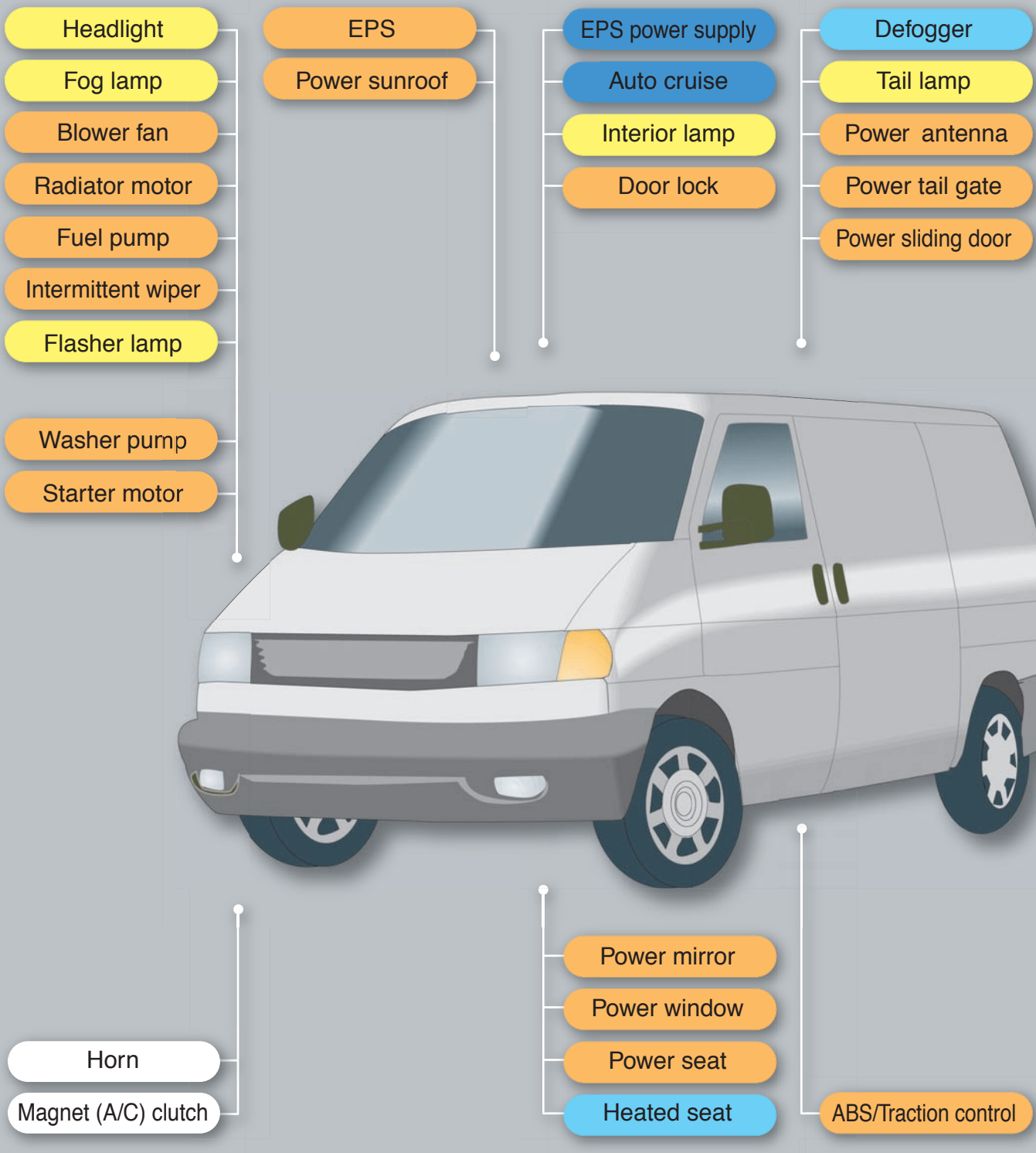





































































































































































Omron's goal is convenience, comfort and safety by providing relays and switches that meet the reliability requirements of the Transportation market while always considering the effect on the environment.

Recommended relays for each purpose and application











Recommended relays for each purpose and application

 Recommended relay to use  Switchable relay

Type	Kind	Model	Appearance	Contact configuration	Coil voltage	Lamp			Motor (Inrush current)			Capacitor (Inrush current)			Resistor			Inductive load		
						240 W	120 W	80 W or less	Over 50 A	50-30 A	30 A or less	Over 150 A	150-100 A	100 A or less	Over 20 A	20-10 A	10 A or less	Magnet clutch	Horn	
Relay for PCB	General purpose	G8N		1c	12 V															
		G8ND		1c x 2	12 V															
		G8NW		1c x 2	12 V															
		G8QN		1c	12 V															
		G8SN		1c	12 V															
	High wattage	G8QE		1a	12 V															
		G8FE		1a	12 V															
		G8SE		1a	12 V															
		G8HL-P		1a	12 V															
		G8PE		1a/1c	12 V															
Plug-in relay	ISO relay	G8HL		1a	12 V															
		G8HN		1a/1c	12V/24 V															
		G8JN		1a/1c	12 V															
		G8JR		1a	12 V															
	280 relay	G8V		1a/1c	12 V															
		G8VA		1a	12 V															
		G8W		1a/1c	12 V															
	JASO relay	G4R		1a	12V/24 V															
		G8MS		1a/1b	12 V															
		G4L		1a	12 V															

Relay Series

Kind		Relay for PCB														
Type		G8N					G8ND			G8NW						
		G8N-1	G8N-1S	G8N-1L	G8N-1H	G8N-1U	G8N-1F	G8ND-2	G8ND-2S	G8ND-2U	G8NW-2	G8NW-2S	G8NW-2L	G8NW-2H	G8NW-2U	G8NW-2F
Model		Standard	Low operating voltage	High heat resistance	High heat resistance and low operating voltage	Super low operating voltage	For Lamp	Standard	Low operating voltage	Super low operating voltage	Standard	Low operating voltage	High heat resistance	High heat resistance and low operating voltage	Low operating voltage	For Lamp
Appearance																
Purpose		DC motor control for transportation components					For flasher lamp	DC motor control for transportation components			DC motor control for transportation components				For flasher lamp	
Contact	Contact configuration	1c(SPDT)					1c x 2(SPDT x 2)(H-Bridge)			1c x 2(SPDT x 2)						
	Contact material	AgSn type (non-cadmium)					PdRu alloy	AgSn type (non-cadmium)						PdRu alloy		
	Rated load	14 VDC 25 A Motor load						14 VDC 25 A Motor load								
	Max switching current	180 A	Motor lock current 30 A 					54 W Lamp: 85 times/min	Motor lock current 30 A 			Motor lock current 30 A 			54 W Lamp: 85 times/min	
		160 A														
	Continuous carry current	140 A	5 A 						5 A 			5 A 				
120 A																
100 A																
80 A																
60 A																
Min applicable load (Reference value)	5 VDC 100 mA					5 VDC 1 A	5 VDC 100 mA						5 VDC 1 A			
Endurance (Lifetime)	Electrical (Rated load)	100,000 times					2000 hours	100,000 times						2000 hours		
	Mechanical	1,000,000 times					10,000,000 times	1,000,000 times						10,000,000 times		
Coil	Rated coil voltage	12 VDC														
	Coil resistant	225 Ω	180 Ω	225 Ω	180 Ω	130 Ω	130 Ω	225 Ω	180 Ω	130 Ω	225 Ω	180 Ω	225 Ω	180 Ω	130 Ω	130 Ω
	Rated power consumption	640 mW	800 mW	640 mW	800 mW	1108 mW	1108mW	640 mW	800 mW	1108mW	640 mW	800 mW	640 mW	800 mW	1108 mW	1108 mW
	Operating voltage	7.2 V or less	6.5 V or less	7.2 V or less	6.5 V or less	5.5 V or less	7.2 V or less	7.2 V or less	6.5 V or less	5.5 V or less	7.2 V or less	6.5 V or less	7.2 V or less	6.5 V or less	5.5 V or less	7.2 V or less
	Release voltage	1.0 V or more				0.8 V or more		1.0 V or more		0.8 V or more		1.0 V or more				0.8 V or more
Withstand voltage	Between a coil and contact	500 VAC: 1 minute														
	Between contacts	500 VAC: 1 minute														
Ambient temperature		-40~+85°C High heat resistance: -40~+105°C					-40~+85°C			-40~+85°C High heat resistance: -40~+105°C						
Protection structure	Unsealed type (In a case)															
	Flux protection type															
	Fully sealed type	○					○			○						
Terminal	Surface mount terminal															
	PCB terminal	○					○			○						
	Plug-in terminal															
Weight (about)		4.0 g					7.5 g			8.0 g						

Relay for PCB													Kind		
G8QN				G8SN	G8QE	G8FE		G8SE		G8HL-P	G8PE		Type		
G8QN-1C4		G8QN-1C4-05		G8QN-1C4-RUC	G8SN-1C4-FD	G8QE-1A	G8FE-1AP G8FE-1AF	G8FE-1AP-L G8FE-1AF-L	G8SE-1A4-E	G8SE-1A4-L	G8HL-1A4P	G8PE-1A4	G8PE-1C4	Model	
Standard	Low operating voltage	High heat resistance	High heat resistance and low operating voltage	For Lamp	Standard	Standard	Standard	Low operating voltage	Standard	High heat resistance	Standard	Standard		Model	
													Appearance		
DC motor control for transportation components				For flasher lamp	DC motor control for transportation components	Head lamp, Tail lamp, Horn	Head lamp, Tail lamp, EPS		Head lamp, Fog lamp, EPS, etc.		Head lamp, EPS, etc.	Blower fan, Defogger, etc.		Purpose	
1c(SPDT)					1a(SPST)							1c(SPDT)	Contact configuration		
AgSn type (non-cadmium)			PdRu alloy		AgSn type (non-cadmium)								Contact material		
14 VDC 25 A Motor load				14 VDC 30 A Motor load		12 VDC 120 W Lamp load	12 VDC 15 A Resistance load		12 VDC 20 A Resistance load		12 VDC 40 A Resistance load	12 VDC 40 A/25 A Resistance load	Rated load		
Motor lock current 30 A 				108 W Lamp: 85 times/min 		Motor lock current 35 A 	Inrush current 60 A 	Inrush current 80 A 	Inrush current 80 A 	Inrush current 60 A 	Inrush current 100 A 	Inrush current 180 A(NO) 	Inrush current 60 A(NC) 	Max switching current 180 A 160 A 140 A 120 A 100 A 80 A 60 A 40 A 20 A	Contact
5 VDC 100 mA				5 VDC 1 A	5 VDC 100 mA	5 VDC 1 A							Min applicable load (Reference value)		
100,000 times				2000 hours	100,000 times							Electrical (Rated load)	Endurance (Lifetime)		
1,000,000 times				10,000,000 times	1,000,000 times							Mechanical			
12 VDC	9 VDC	12 VDC	9 VDC	DC12V										Rated coil voltage	
210 Ω	180 Ω	210 Ω	180 Ω	210 Ω	210 Ω	320 Ω	180 Ω	180 Ω	225 Ω	225 Ω	320 Ω	135 Ω	135 Ω	Coil resistant	
686 mW	450 mW	686 mW	450 mW	686 mW	686 mW	450 mW	800 mW	800 mW	640 mW	640 mW	450 mW	1067m W	1067 mW	Rated power consumption	
7.3 V or less	6.5 V or less	7.3 V or less	6.5 V or less	7.3 V or less	6.5 V or less	8.0 V or less	7.3 V or less	6.0 V or less	7.3 V or less	7.3 V or less	8.0 V or less	7.0 V or less	6.8 V or less	Operating voltage	
1.2 V or more	0.6 V or more	1.2 V or more	0.6 V or more	1.2 V or more	0.9 V or more	1.0 V or more			1.2 V or more		0.7 V or more	1.0 V or more	Release voltage		
500 VAC: 1 minute													Between a coil and contact	Withstand voltage	
500 VAC: 1 minute													Between contacts		
-40~+85°C High heat resistance: -40~+105°C				-40~+85°C		-40~+105°C			-40~+85°C High heat resistance: -40~+110°C		-40~+100°C	-40~+105°C		Ambient temperature	
													Unsealed type (In a case)	Protection structure	
													Flux protection type		
○													Fully sealed type		
													Surface mount terminal	Terminal	
○													PCB terminal		
													Plug-in terminal		
6.0 g				12.5 g		6.0 g	8.7 g		16.0 g		13.0 g	20.0 g		Weight (about)	

Relay Series

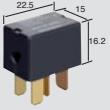
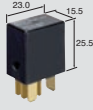
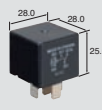
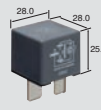
Kind		ISO relay																		
Type		G8HL		G8HN				G8JN	G8JR											
		G8HL-1A4T-R		G8HN-1A2T-RJ	G8HN-1C2T-RJ		G8HN-1A2T-RH	G8HN-1C2T-RH	G8JN-1C2T-R	G8JR-1A2T-R										
Model		Standard		Standard		High wattage		Standard	Standard											
Appearance																				
Purpose		Head lamp, Blower fan, Defogger, etc.		Head lamp, Blower fan, Defogger, etc.				Blower fan, Defogger, etc.	Blower fan, etc.											
Contact		Contact configuration		1a(SPST)		1c(SPDT)		1a(SPST)	1c(SPDT)	1a(SPST) 1c(SPDT)	1a(SPST)									
		Contact material		AgSn type (non-cadmium)																
		Rated load		12 VDC 20 A Resistance load		12 VDC 20 A Resistance load	24 VDC 10 A Resistance load	12 VDC 20 A/10 A Resistance load		24 VDC 10 A/5 A Resistance load	12 VDC 35 A Resistance load	12 VDC 35 A/20 A Resistance load	12 VDC 35 A/20 A Resistance load	12 VDC 50 A Resistance load						
		Max switching current		180 A 160 A 140 A 120 A 100 A 80 A 60 A 40 A 20 A		Inrush current 100 A	Inrush current 100 A	Inrush current 30 A	Inrush current 100 A(NO)		Inrush current 30 A(NC)	Inrush current 30 A	Inrush current 120 A	Inrush current 120 A(NO)	Inrush current 40 A(NC)	Inrush current 120 A(NO)	Inrush current 40 A(NC)	Inrush current 150 A		
		Continuous carry current		10 A 20 A 30 A 40 A 50 A		20 A		20 A	10 A	20 A(NO)		10 A(NC)	10A(NO)	5 A(NC)	35 A	35 A(NO)	20 A(NC)	35 A(NO)	20 A(NC)	50 A
		Min applicable load (Reference value)		5 VDC 1 A																
Endurance (Lifetime)		Electrical (Rated load)		100,000 times																
		Mechanical		1,000,000 times																
Coil		Rated coil voltage		12 VDC		24 VDC	12 VDC		12 VDC	12 VDC										
		Coil resistant		Between terminals 150 Ω	Between terminals 95.9 Ω	Between terminals 315.1 Ω	Between terminals 95.9 Ω	Between terminals 315.1 Ω	Between terminals 124.2 Ω		Between terminals 70 Ω	Between terminals 62.7 Ω								
		Rated power consumption		0.96 W	1.51 W	1.83 W	1.51 W	1.83 W	1.16 W		2.06 W	2.30 W								
		Operating voltage		8.0 V or less		8.0 V or less	16.0 V or less	8.0 V or less		16.0 V or less	8.0 V or less									
		Release voltage		0.7 V or more		1.2 V or more	2.4 V or more	1.2 V or more		2.4 V or more	1.2 V or more		1.0 V or more							
Withstand voltage		Between a coil and contact		500 VAC: 1 minute																
		Between contacts		500 VAC: 1 minute																
Ambient temperature		-40~+100°C		-40~+125°C				-40~+135°C												
Protection structure		Unsealed type (In a case)						○		○	○									
		Flux protection type																		
		Fully sealed type		○						○										
Terminal		Surface mount terminal																		
		PCB terminal																		
		Plug-in terminal		○						○		○	○							
Weight (about)		14 g		20 g				34 g		39 g										

280 relay					JASO relay			Kind		
G8V		G8VA	G8W		G4R	G8MS	G4L	Type		
G8V-1A2T-R	G8V-1C2T-R	G8VA-1A4T-R	G8W-1A2T-R	G8W-1C2T-R				Model		
Standard		Standard	Standard		Standard	Standard	Low operation sound	Appearance		
								Purpose		
Head lamp, Fog lamp, Horn lamp, etc.			Motor, Fan, Solenoid, etc.		Head lamp, Blower fan, Defogger, etc.	Head lamp, Blower fan, etc.	Air conditioner and magnet clutch etc.			
1a(SPST)	1c(SPDT)	1a(SPST)	1c(SPDT)	1a(SPST)		1b(SPST)	1a(SPST)	Contact configuration	Contact material	
AgSn type (non-cadmium)				AgSn type (non-cadmium)						
12 VDC 20 A Resistance load	12 VDC 20 A/10 A Resistance load	14 VDC 15 A Resistance load	12 VDC 35 A Resistance load	12 VDC 35 A/20 A Resistance load	12 VDC 25 A Resistance load	24 VDC 15 A Resistance load	12 VDC 20 A Resistance load	12 VDC 10 A Resistance load	12 VDC 20 A Resistance load	Rated load
Inrush current 60 A 	Inrush current 60 A(NO) Inrush current 30 A(NC) 	Inrush current 80 A 	Inrush current 120 A 	Inrush current 120 A(NO) Inrush current 40 A(NC) 	Inrush current 120 A 	Inrush current 65 A 	Inrush current 100 A 	Inrush current 60 A 	Inrush current 100 A 	Max switching current 180 A 160 A 140 A 120 A 100 A 80 A 60 A 40 A 20 A
20 A	20 A(NO) 10 A(NC)	15 A	35 A	35 A(NO) 20 A(NC)	25 A	15 A	20 A	10 A	20 A	Continuous carry current 10 A 20 A 30 A 40 A 50 A
5 VDC 1 A					5 VDC 1 A					Min applicable load (Reference value)
100,000 times					100,000 times					Electrical (Rated load)
1,000,000 times					1,000,000 times					Mechanical
12 VDC					12 VDC	24 VDC	12 VDC			Rated coil voltage
Between terminals 62.7 Ω	Between terminals 132 Ω	Between terminals 78 Ω			Between terminals 100 Ω	Between terminals 400 Ω	Between terminals 100 Ω	Between terminals 130 Ω	Coil resistant	
2.30 W	1.10 W	1.85 W			1.44 W			1.11 W	Rated power consumption	
8.0 V or less	7.5V or less	8.0 V or less			8.0 V or less	16.0 V or less	8.0 V or less	8.0 V or less	Operating voltage	
1.0 V or more	1.0V or more	1.0 V or more			0.6 V or more	1.2 V or more	0.6 V or more	1.2 V or more	Release voltage	
500 VAC: 1 minute					500 VAC: 1 minute					Between a coil and contact
500 VAC: 1 minute					500 VAC: 1 minute					Between contacts
-40~+125°C	-30~+100°C	-40~+125°C			-40~+80°C	-40~+100°C	-40~+80°C			Ambient temperature
○		○			○	○	○			Protection structure
	○						○			
										Surface mount terminal
										PCB terminal
○	○	○			○	○	○			Plug-in terminal
19.3 g	10 g	34 g			53 g	32 g	30 g			Weight (about)

Glossary: Terms related to relays

The meaning of terms used in this catalog are stated below.

1 Coil

● Coil Symbol

Coil drive types are displayed as below.

mono -stable	
Polarized	Non-polarized

● Rated Coil Voltage

A reference voltage applied to the coil when the relay is used under the normal operating conditions.

● Rated Coil Current

The current which flows through the coil when the rated voltage is applied at a temperature of 20°C. The tolerance is +15°C/ -20°C unless otherwise specified.

● Coil Resistance

The resistance of the coil, measured at a temperature of 20°C. A tolerance of ±10% shall apply unless otherwise noted.

● Coil Power Consumption

The power dissipated by the coil when the rated voltage is applied to it. The coil power consumption is equal to the Rated Coil Voltage multiplied by the Rated Coil Current.

● Pull In Voltage (Must Operate Voltage)

The minimum coil voltage required to pull-in the relay contacts at a temperature of 20°C.

● Drop Out Voltage (Release Voltage)

The minimum coil voltage at which a relay's contacts will drop-out at a temperature of 20°C.

● Hot Start

The Minimum Operate Voltage when measured immediately following a pre-determined operating condition.

● Voltage Range

The region of safe operating potential applied to the coil.

● Maximum Continuous Coil Voltage

The voltage that can be continuously applied to the coil without exceeding the maximum temperature limits.

2 Contacts

● Contact Form

The contact mechanism of the relay. Classification of the relay contact configuration. The most common types in automotive applications are "A-Form" (SPST) and "C-Form" (SPDT).

● Contact Symbol

The symbol for each contact mechanism is displayed as below.

	a-contact	b-contact	c-contact
Contact symbol in the catalog			
Contact symbol in the JIS			

Note: JIS contact symbol is used in "Glossary: Terms related to relays" and "Notice related to relays" except for special cases.

● Contact Rating

An expression of the voltage, current, or ambient temperature (or any combination thereof) that a relay's contacts may be exposed to while being expected to retain acceptable operating characteristics.

● Maximum Continuous Current Rating

The current that can be continuously carried through the contacts without exceeding the maximum temperature limits.

● Maximum Switching Power

The maximum wattage that can be switched without exceeding the design parameters of the relay. Care should be taken to not exceed this value. (VA is used in the case of AC. W is used in the case of DC.)

● Contact Resistance

The total electrical resistance of a pair of closed contacts measured at their associated contact terminals. The contact resistance values in this catalog are initial rated values; therefore they are not an indicator of pass or fail after actual use in the application circuitry.

Contact resistance is determined by measuring the voltage drop across the contacts using the appropriate test current shown below.

$$\text{Contact Resistance} = \frac{E}{I} (\Omega) \left(\begin{array}{l} \text{DC measurements are obtained by} \\ \text{testing with alternating polarities and} \\ \text{adopting the mean value.} \end{array} \right)$$

Contact Resistance Test Current

Rated current or switched current (A)	Test current (mA)
0.1 or higher but less than 1	100
1 or higher	1,000

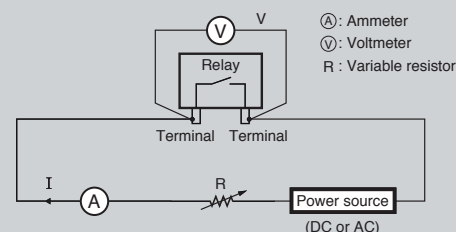

● Maximum Contact Voltage

The maximum value of contact voltage that the contact can withstand. Do not apply a voltage that exceeds the maximum contact voltage of the relay.

● Maximum Switching Current (contact)

The maximum value of the contact current that the contact can safely switch. Do not apply a current that exceeds the maximum contact switching rating of the relay (this includes inrush.)

Glossary: Terms related to relays

3 Electrical Characteristics

● Operate Time

The time that elapses between the instant power is applied to a relay coil and the moment the contacts have closed. In case the relay has several contacts, the duration of the operate time shall be considered to end when the last contact has closed unless otherwise specified. Release time is always specified at 20°C unless otherwise noted. Operate bounce time is not included in the operate time of a relay.

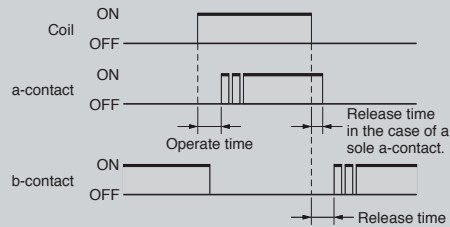

● Release Time

For an SPDT relay, the release time is the time that elapses between the instant a relay coil is de-energized, and closure of the NC contacts. For an SPST relay, the release time concludes at the opening of the NO contacts. Release time is specified at 20°C unless otherwise noted. Release bounce time is not included in the release time of a relay.

● Bounce

Intermittent opening and closing of contacts caused by vibration or shock resulting from the collision of the relay's moving parts.

● Operate Bounce Time

The time interval between the initial closure of the NO contact and when the bounce ceases.

● Release Bounce Time

The time interval between the initial closure of the NC contact and when the bounce ceases.

● Insulation Resistance

The resistance between any two electrically conductive parts within the relay that are intended to be electrically isolated from each other.

Typical examples would include:

1. Between the coil and contact: Between the coil terminal and all contact terminals
2. Between contacts of a different polarity: Between contact terminals of a different polarity
3. Between contacts of the same polarity: Between contact terminals of the same polarity

● Dielectric Strength

The ability of electrically isolated parts within the relay to withstand high voltage applied across them without arcing. Typically, an acceptable leakage current is established at a particular voltage for a specified duration.

4 Mechanical Characteristics

● Vibration Resistance

Vibration resistance of a relay is characterized by two values:

Malfunction Durability, refers to the maximum vibration the relay can withstand without changing state (vibration doesn't cause closed contacts to open or open contacts to close).

Mechanical Durability, refers to the maximum vibration the relay can withstand without causing it to permanently change its operating characteristics.

● Shock Resistance

Shock Resistance of a relay is characterized by two values:

Malfunction Durability, refers to the maximum shock the relay can withstand without changing state (vibration doesn't cause closed contacts to open or open contacts to close.)

Mechanical Durability, refers to the maximum shock the relay can withstand without causing it to permanently change its operating characteristics.

5 Endurance (Lifetime)

● Mechanical Endurance (Lifetime)

The number of operations the relay can successfully complete without any electrical load.

● Electrical Endurance (Lifetime)

The number of operations the relay can successfully complete with the rated load applied. Electrical endurance is not indicative of relay performance for loads other than the rated load.

● Minimum Carry or Switching Current

The smallest acceptable value of carry or switching current that maintains reliable electrical performance of the contacts.

● Maximum Operating Frequency

The maximum frequency at which the relay coil may be energized and de-energized while maintaining consistent and predictable operation.

6 Ambient Temperature Range (When using, transporting and storing the relay)

The temperature limits under which the relay can predictably operate are indicated on the data sheet. However, any freezing condition is excluded.

This does not guarantee to meet the values given on the data sheet for the entire operating temperature range.

Glossary: Terms related to relays

7 Contour and Shape

● Contour Dimension

Relay for automobile PCB

For miniature relays, dimensions (either nominal or maximum) are provided to aid the customer in the design process.

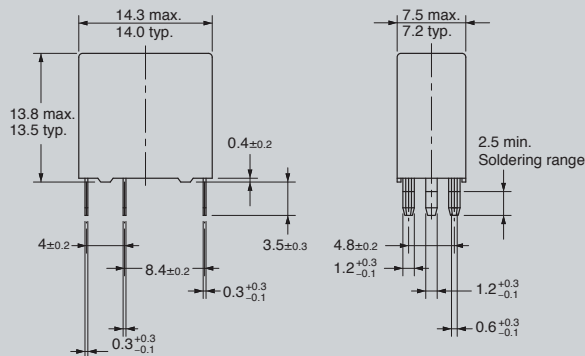

General purpose relay

Maximum dimensions are shown as a reference for design.

● Marking

Various markings are used such as relay type, voltage rating, internal connection diagram, etc. Because of space restrictions on the surface of smaller relays, they may not display all of the information found on larger relays.

● Mounting Orientation Mark

The top of all Omron relays are marked to indicate the location of the relay coil. Knowing the terminal location aids in designing PCB patterns, and when spacing components. Also, the printing makes it easy to discern pin orientation when automatic or hand-mounting the relay.

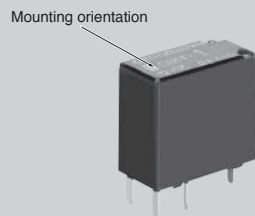

● Terminal Layout/Internal Connection

(1) Bottom View

When a relay's terminals can not be seen from top view (such as in the example below), the BOTTOM VIEW is shown in the catalog.



(2) Rotation direction to BOTTOM VIEW

The bottom view shown in the catalog or data sheet is rotated in the direction indicated by the arrow, with the coil always on the left.

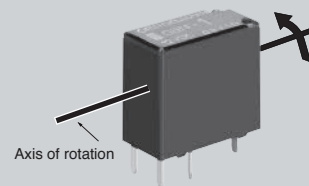

	PCB processing dimension	Terminal layout/Internal Connection
Symbol		
Example	<p>Directional mark</p> <p>(BOTTOM VIEW)</p>	<p>Directional mark</p> <p>(BOTTOM VIEW)</p>

Note: In a contour dimensional drawing, PCB process dimensional drawing or terminal layout/internal connection diagram, the directional mark is found on the left. JIS contact symbol is not inscribed to match with case marking.

Switch Series

Technical Considerations

Omron Electronic Components has a great variety of standard options. We can deliver a snap action switch that will drop right into your application. Saving you time, component counts, & cost while improving your products overall quality.

These options include:

Actuators:

- Long & short panel mount plungers
- Long & short spring plungers
- Hinge levers in various lengths & orientation
- Roller levers in various lengths & orientations
- Simulated roller
- Leaf

Termination styles:

- PCB
- Solder
- Quick Connect
- Screw
- Wire Leads
- Connector

Additional Features:

- Sealed / Unsealed versions available.
- Class N (200C) types available. (D3V-T)

Contact Omron Components and have it your way. Configure a switch that meets your application needs.

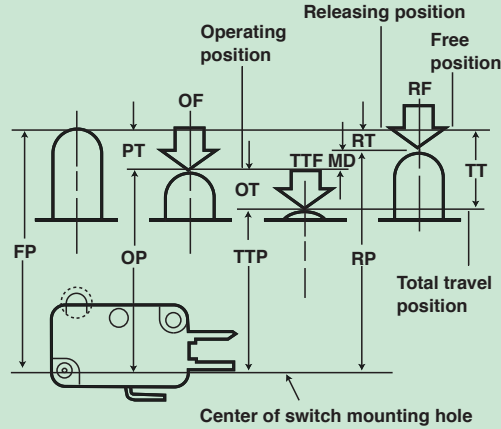



Plunger & Lever Options

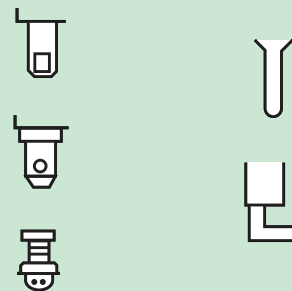

Terminal Options





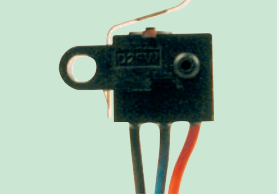
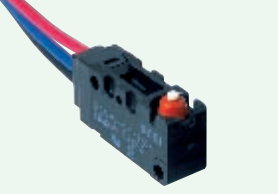

Switch Series

				
	D2HW	D2JW	D2FW-G	D2VW
Dimensions mm (in)	7 H x 5.3 D x 13.3/18.5 W (0.28 x 0.21 x 0.52/0.73)	9.4 H x 5.3 D x 12.7 W (0.37 x 0.21 x 0.50)	13.5 H x 8.0 D x 23.5 W (0.53 x 0.31 x 0.93)	15.9 H x 10.3 D x 33 W (0.63 x 0.41 x 1.29)
Features	<ul style="list-style-type: none"> • Subminiature Snap Action Switch • Small sealed switch with long stroke for reliable ON/OFF action • Conforms to IP67 	<ul style="list-style-type: none"> • Small size • Gold crossbar contact and coilspring for long life • IP67 rating for molded lead wire versions 	<ul style="list-style-type: none"> • Subminiature Snap Action Switch • Small sealed switch with lead wires • Conforms to IP67 	<ul style="list-style-type: none"> • Miniature Snap Action Switch • Sealed water-tight switch conforms to IP67 & IP68
Contact Rating(s) Resistive load	2A @ 12VDC/ 1A @ 24VDC/ 0.5A @ 42VDC	0.1A @ 30VDC	0.5A @ 30VDC or 50mA @ 30VDC	0.1A @ 125VAC or 5A @ 125/250VAC
Contact form	SPDT, SPST-NC, SPST-NO	SPDT	SPDT, SPST-NC, SPST-NO	SPDT (SPST-NC, SPST-NO per request)
Operating force (OF)*	76g	250g	120g	200g
Mechanical service life	1,000,000 operations min.	1,000,000 operations min.	300,000 operations min.	10,000,000 operations min.
Electrical service life	100,000 operations min.	500,000 operations min.	100,000 operations min.	1,000,000 operations min. (0.1A, 125VAC) 100,000 operations min. (3A, 125/250VAC)
Mounting pitch mm (in)	8 (0.32) posts, 13 (0.51) screw	4.8	16 (0.63)	10.3 x 22.2 (0.41 x 0.87)
Actuator types	Pin plunger, hinge lever, long hinge lever, simulated roller lever, leaf lever, simulated leaf lever, long leaf lever	Pin plunger, short hinge lever, hinge lever, simulated roller lever, hinge roller lever	Leaf lever, Long leaf lever	Pin plunger, short hinge lever, hinge lever, long hinge lever, simulated roller lever, short hinge roller lever, hinge roller lever
Terminal choices	PCB (straight, angled), Solder, Lead wire (bottom, right side, left side)	Solder, molded lead wire	Lead wires	Solder/Quick connect (#187 tab terminals) lead wires
Approved standards	UL, CSA	UL, CSA, VDE	-	UL, CSA (refer to "Ratings" section of data sheet)

* Values are for pin plunger type only





Switch Series

				
	D2SW	D2QW	D2F	SS-P/SS
Dimensions mm (in)	10.1 H x 6.4 D x 19.8 W (0.40 x 0.25 x 0.78)	9.3 H x 5.3 D x 13.3 W (0.37 x 0.21 x 0.53)	6.5 H x 5.8 D x 12.8 W (0.26 x 0.23 x 0.50)	10.2 H x 6.4 D x 19.8 W (0.40 x 0.25 x 0.78)
Features	<ul style="list-style-type: none"> • Subminiature snap action switch • Small sealed switch conforms to IP67 & IP68 	<ul style="list-style-type: none"> • Sealed Long-travel Detection switch • Quite operating sound by sliding contact construction 	<ul style="list-style-type: none"> • Subminiature Snap Action Switch • Switches microvoltage/micro-current loads • Long lifespan assured by high-precision dual spring reverse-action mechanism 	<ul style="list-style-type: none"> • Subminiature Snap Action Switch • SS-01: Switches microcurrent/microvoltage load with cross-bar contacts • SS-3: Single-leaf movable spring • SS-5: Split double spring mechanism for a long life of up to 30 million operations • SS-10: Split double spring mechanism for a long life of up to 10 million operations • Internal lever options
Contact Rating(s) Resistive load	0.1A @ 125VAC or 3A @ 125VAC	0.1A @ 30VDC	0.1A @ 30VDC (D2F-01) 3A @ 125VAC (D2F) 1A @ 125VAC (D2F-F)	0.1A @ 125VAC (SS-01) 3A @ 125VAC (SS-3) 5A @ 125VAC (SS-5) 10.1A @ 125/250VAC (SS-10)
Contact form	SPDT (SPST-NC, SPST-NO per request)	SPST-NO	SPDT	SPDT (SPST-NC, SPST-NO per request)
Operating force (OF)*	180g	1.5g	75g (D2F-01) 150g (D2F) 75g (D2F-F)	25g, 50g, or 150g (SS-01) 150g (SS-3) 50g or 150g (SS-5) 150g (SS-10)
Mechanical service life	5,000,000 operations min.	1,000,000 operations min.	1,000,000 operations min.	30,000,000 ops.min. (SS-01, SS-05)* 1,000,000 ops.min. (SS-01P, SS-3) 10,000,000 ops.min. (SS-10)*
Electrical service life	200,000 operations min. (0.1 or 3A, 125VAC) 100,000 operations min. (2A, 250VAC)	100,000 operations min. (OT; full stroke)	30,000 operations min. (OT; full stroke)	200,000 operations min. (SS-01, SS-5)** 70,000 operations min. (SS-3) 50,000 operations min. (SS-10)**
Mounting pitch mm (in)	9.5 (0.37)	4.38 (0.17)	6.5 (0.26)	9.5 (0.37)
Actuator types	Pin plunger, hinge lever, simulated roller lever, hinge roller lever	Pin plunger, hinge lever, simulated roller lever, roller lever	Pin plunger, hinge lever, simulated roller lever, roller lever	Pin plunger, hinge lever, simulated roller lever, formed hinge lever, hinge roller lever
Terminal choices	Solder, Quick connect (#110), PCB, lead wires	PCB, Solder, Lead Wire	PCB (straight, self-supporting, right and left angle), Solder	SS-01, SS-3, SS-5: PCB (straight, parallel left, parallel right), Solder, Quick connect SS-10: PCB (straight), Solder, Quick connect (#110)
Approved standards	UL, CSA	-	UL, CSA	UL, CSA

* Values are for pin plunger type only
 *at rated OT value
 **at rated load

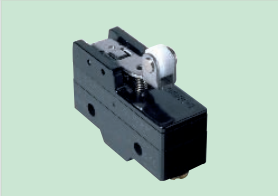
Switch Series

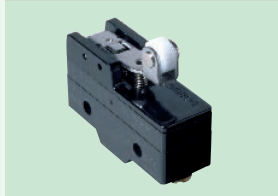
Snap Action

				
	Z	A	X	DZ
Dimensions mm (in)	24.2 H x 17.45 D x 49.2 W (0.95 x 0.69 x 1.93)	24.2 H x 17.45 D x 49.2 W (0.95 x 0.69 x 1.93)	24.2 H x 17.45 D x 49.2 W (0.95 x 0.69 x 1.93)	22.7 H x 17.45 D x 49.2 W (0.89 x 0.69 x 1.93)
Features	<ul style="list-style-type: none"> • General Purpose Snap Action Switch • High precision 15 A switch available in a variety of styles 	<ul style="list-style-type: none"> • General Purpose Snap Action Switch • High capacity switch handles loads with large inrush currents 	<ul style="list-style-type: none"> • DC switch • Magnetic blowout to extinguish arc 	<ul style="list-style-type: none"> • DPDT basic switch • Incorporates two completely independent built-in switches • Can switch two independent circuits operating on different voltages
Contact Rating(s) Resistive load	0.1A @ 125VAC 15A @ 250VAC*	20A @ 250VAC	10A @ 125VDC 3 A @ 250VDC	10A @ 250VAC
Contact form	SPDT	SPDT	SPDT	DPDT
Operating force (OF)*	250g to 350g	400g to 625g	510g	570g
Mechanical service life	Refer to "SPECIFICATIONS" section of data sheet for detailed service life information	1,000,000 ops. min. (at rated OT load)	1,000,000 operations min.	1,000,000 operations min.
Electrical service life	Refer to "SPECIFICATIONS" section of data sheet for detailed service life information	500,000 ops. min. (at rated OT load)	100,000 operations min.	500,000 operations min.
Mounting pitch mm (in)	25.4 (1.0)	25.4 (1.0)	25.4 (1.0)	25.4 (1.0)
Actuator types	Pin plunger, slim spring plunger, short spring plunger, panel mount plunger, panel mount roller plunger, panel mount cross roller plunger, hinge lever, low force hinge lever, short hinge roller lever, hinge roller lever, unidirectional short hinge roller lever, spring plunger, flexible rod	Pin plunger, short spring plunger, panel mount plunger, panel mount roller plunger, panel mount cross roller, short hinge lever, hinge lever, short hinge roller lever, hinge roller lever	Pin plunger, short spring plunger, slim spring plunger, panel mount plunger, panel mount cross-roller plunger, panel mount roller plunger, leaf spring, hinge lever, hinge roller lever, short hinge lever, short hinge roller lever	Pin plunger, hinge lever, short hinge roller lever, hinge roller lever
Terminal choices	Solder, Screw	Solder, Screw, or Quick connect (#250)	Solder, Screw	Solder, Screw
Approved standards	UL, CSA, SEV	UL, CSA, SEV	UL, CSA	UL, CSA

*Values are for pin plunger type only

World-Wide Headquarter Locations



Japan – World Headquarters

Japan

OMRON ELECTRONIC COMPONENTS

Kyoto Head Office

Shiokoji Horikawa, Shimogyo-ku, Kyoto, 600-8530
Japan — Tel : 81-75-344-7000 Fax : 81-75-344-7001

Europe

OMRON ELECTRONIC COMPONENTS

EUROPE B.V.

(OCB-EU-Benelux)

Wegalaan 57, 2132 JD Hoofddorp
The Netherlands — TEL : 31-23-568-1200 FAX : 31-23-568-1212

Asia-Pacific

SINGAPORE

OMRON ELECTRONIC COMPONENTS PTE LTD.

(OCB-SG)

750B Chai Chee Road #01-02 Technopark@Chai Chee
Singapore 469002 — TEL : 65-7446-7400 FAX : 65-6446-7411

China

HONG KONG

OMRON ELECTRONIC COMPONENTS

(HONG KONG) LTD.

(OCB-HK)

Unit 601-9, Tower 2, Th Gateway No.25, Canton Road, Tsimshatsui, Kowloon
Hong Kong — TEL : 852-2375-3827 FAX : 852-2375-1475

CHINA

OMRON ELECTRONIC COMPONENTS

TRADING (SHANGHAI) LTD. SHANGHAI OFFICE

(OCB-CN(SH))

Rm2503, Raffles City Shanghai (Office Tower), No.268 Xi Zang Middle Road, Huang Pu District, Shanghai, 200001
China — TEL : 86-21-6340-3737 FAX : 86-21-6340-3757

The Americas

U.S.A. / Canada / Brazil - HQ

OMRON ELECTRONIC COMPONENTS LLC

(OCB-AM)

55 East Commerce Drive, Suite B, Illinois, 60173
U.S.A. — TEL : 1-847-882-2288 FAX : 1-847-882-2192

Omron Electronic Components: The Quality, Flexibility and Global Support You Need

Omron leads the world in advanced relay production and quality, assuring reliable performance, and ready stock wherever you manufacture. With 75 years of experience, we continue to apply the latest technologies to offer you smaller, faster and more efficient components for a wide range of applications. Our global network of sales and technical support can also provide a full line of advanced micro sensors, photomicrosensors, electro-mechanical switches and flexible PCB connectors.

For More Detailed Information...

Visit Us Online:

www.components.omron.com

- Browse Omron's full range of product information and selection guides.
- Search the cross-reference database to locate Omron component solutions.
- Download PDF data sheets, brochures and more.
- Locate a Distributor and search for available inventory.
- Complete Terms and Conditions of Sale and Usage.

Call Us:

1-847-882-2288 Monday through Friday,
7:30 a.m. to 6:00 p.m. Central Time (CT)

Email Us:

components@omron.com

OMRON ELECTRONIC COMPONENTS LLC

55 Commerce Drive, Schaumburg, IL 60173 U.S.A.



6675 Parkland Blvd, Solon, OH 44139 USA
Toll Free: 1-800-722-5273 • Phone: 440-836-6600
Fax: 440-836-6122
E-mail: salesna@powersignal.com
www.powerandsignal.com

REQUIRED PRECAUTIONS

It is the buyer's sole responsibility to ensure that any omron product is fit and sufficient for use in a motorized vehicle application. Buyer shall be solely responsible for determining appropriateness of the particular product with respect to the buyer's application, end product, or system. Buyer shall take the application responsibility in all cases, but the following is a non-exhaustive list of applications for which particular attention must be given:

- Outdoor use; uses involving potential chemical contamination or electrical interference, or conditions or uses not described in this document.
 - Use in consumer products or any use in significant quantities.
 - Energy control systems, combustion systems, railroad systems, aviation systems, medical equipment, amusement machines, vehicles, safety equipment, and installations subject to separate industry or government regulations.
 - Systems, machines, and equipment that could present a risk to life or property.
- Never use the product for an application involving serious risk to life or property or in large quantities without ensuring that the end product as a whole has been designed to address relevant risks, and that the omron product is properly rated and installed for its intended use.

Mouser Electronics

Authorized Distributor

Click to View Pricing, Inventory, Delivery & Lifecycle Information:

[Omron:](#)

[G8QE-1A DC12](#)